



HEAT CONTROLLER

PARTS LIST

Inverter Single Zone Indoor Ductless Mini-Split

B-VMH09SU-1

EXPLODED VIEW

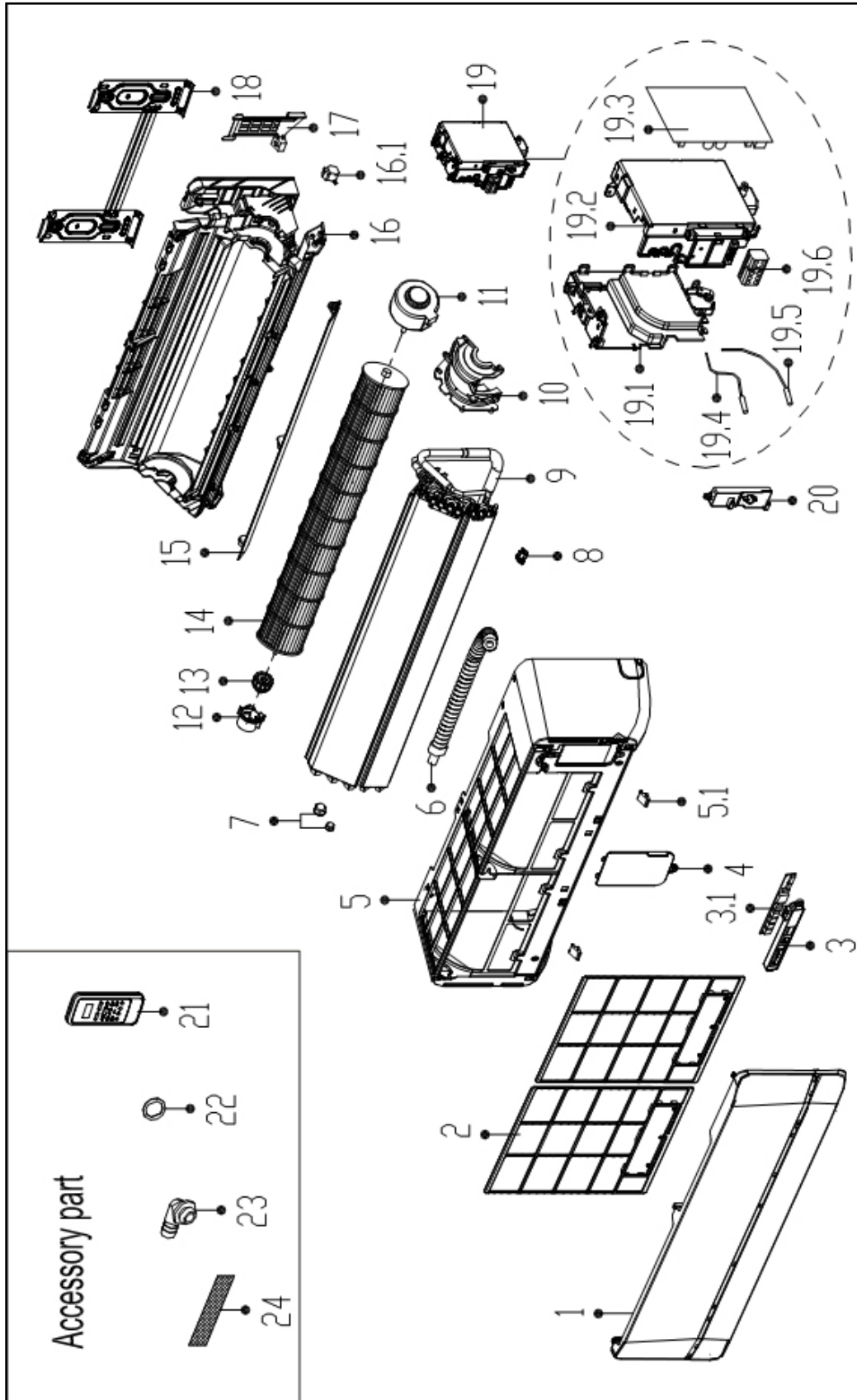

REPLACEMENT PARTS

Location	Part Name	Quantity	Part No.
1	Panel assembly	1	12122000A04735
2	Air filter	2	12100204000466
3	Display box assembly	1	17222000A01003
3.1	Display board assembly	1	17122000A02033
4	Cover of electrical equipment	1	12122000006694
5	Panel frame assembly	1	12122000001971
5.1	Screw cap	2	12122000006272
6	Drain hose	1	12100501000021
7	Pipe nut or copper nut	1	15500406000010
7	Pipe nut or copper nut	1	15500406000016
8	Fix clamp of temperature sensor	1	12100303000008
9	Evaporator assembly	1	15822000A04390
10	Fan motor cover	1	12122000005431
11	Brushless DC motor	1	11002015000051
12	Bearing holder	1	12122000000350
13	Bearing base	1	12622000000006
14	Cross flow fan	1	12100102000074
15	Horizontal louver	1	12122000005101
16	Chassis assembly	1	12122000009003
16.1	Louver motor	1	11002010000143
17	Pipe clamp board	1	12122000000455
18	Installation plate	1	12222000000031
19	Electronic control box assembly	1	17222000007378
19.1	Electronic control box I	1	12122000004586
19.3	Indoor main control board assembly	1	17122000014254
19.4	Ambient temperature sensor assembly	1	11201007000088
19.5	Pipe temperature sensor assembly	1	11201007000001
19.6	Wire joint	1	17400401000006
20	Cover of electronic control box	1	12122000004994
21	Remote Controller	1	17317000A06980
22	Seal ring	1	12600701000039
23	Drain joint	1	12100509000061
24	Air freshening filter	1	12100206000056



Due to ongoing product improvements, specifications and dimensions are subject to change and correction without notice or incurring obligations. Determining the application and suitability for use of any product is the responsibility of the installer. Additionally, the installer is responsible for verifying dimensional data on the actual product prior to beginning any installation preparations.

Incentive and rebate programs have precise requirements as to product performance and certification. All products meet applicable regulations in effect on date of manufacture; however, certifications are not necessarily granted for the life of a product. Therefore, it is the responsibility of the applicant to determine whether a specific model qualifies for these incentive/rebate programs.



1900 Wellworth Ave., Jackson, MI 49203 • Ph. 517-787-2100 • www.comfort-aire.com • www.century-hvac.com



www.marsdelivers.com • www.heatcontroller.com